

ADD-A-BATHROOM

MODULAR SHOWERS



FPS980 (Flat Packed Shower)

If you're renovating an existing bathroom or building a new one and want the advantages of an easy to clean, no maintenance waterproof shower, then an Add-A-Bathroom shower cubicle is what you need.

All Add-A-Bathroom fully moulded shower cubicles have a specially designed anti-slip base and are made from sanitary grade materials. All cubicles can be fitted with a glass shower screen or stainless steel curtain rail.

Our showers are designed and manufactured with no sharp corners and have a glossy, durable surface finish that is a breeze to clean with most proprietary brand bathroom cleaners.

Our range of flat packed showers (FPS) is designed to make transportation and storage more cost effective. These units are a breeze to assemble and come complete with all fixings and sanitary grade sealant. All flat packed models can be fitted with a glass shower screen or stainless steel curtain rail.

We use only quality bathroom hardware.



900MS



Choose from a large range of shower hardware

ADELAIDE • BRISBANE • DARWIN • MELBOURNE • PERTH • SYDNEY

FULLY MOULDED SHOWERS

All sizes are in millimetres. The **HS** units shown in **Red** have a higher entry hob. Scale of drawing is approximate only.

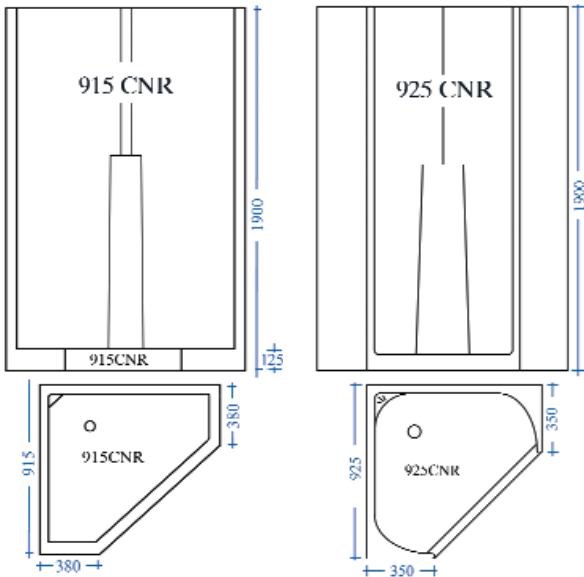
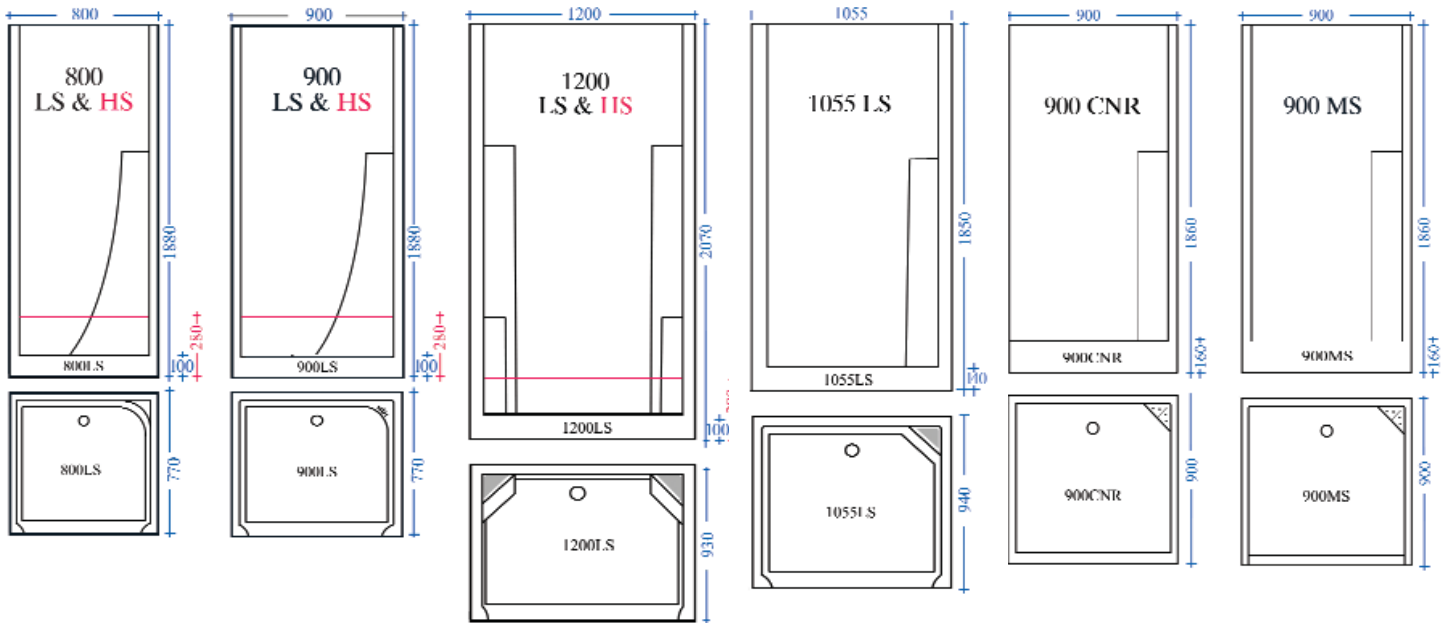

FLAT PACK SHOWERS

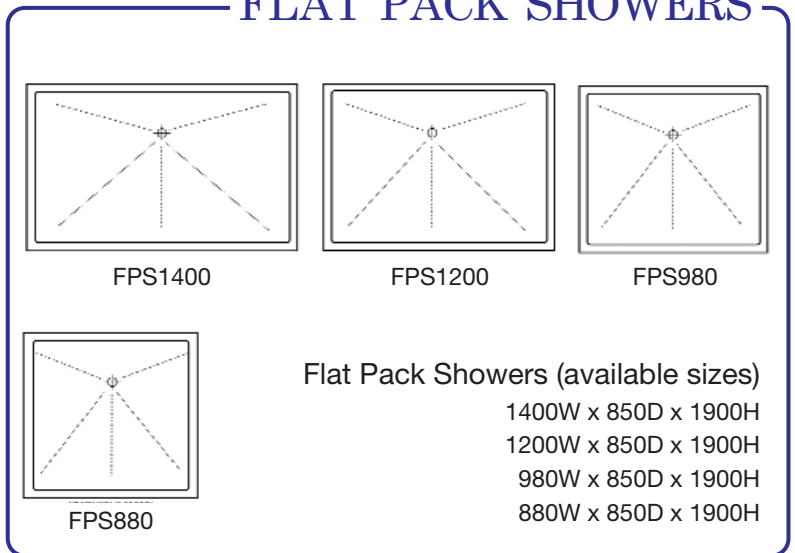

Available from

To locate your nearest **ADD-A-BATHROOM** distributor visit our website or Ph: 1300 559 121

International Ph: +61 8 8260 7729 • Facsimile: +61 8 8260 2699

Email: info@addabathroom.com.au Web: www.addabathroom.com.au

Before deciding on your Add-A-Bathroom model please ensure appropriate access is available to the site for the model chosen and specifications confirmed as all specifications are nominal and subject to alteration without notice. Information provided is for general information purposes only and does not take personal circumstances into account.